

NO.	COUNT	REVISIONS	DATE (YY/MM/DD)	APPROVED
△	x		' / /	
△	x		' / /	
.	x		' / /	

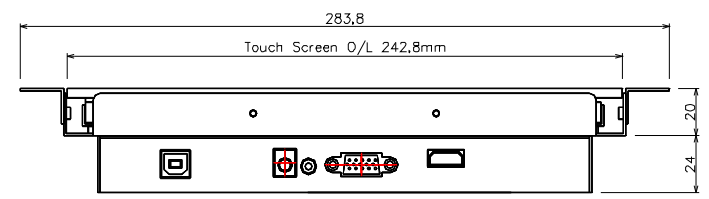

UNLESS OTHERWISE SPECIFIED, DIMENSIONS ARE IN MILLIMETERS AND TOLERANCES ARE AS FOLLOWS:		SIZE	SCALE	QUANTITY	MATERIAL	REMARK		
0 - 6	±0.08	 ANGULAR TOLERANCE: ±0.5°	DRAWN	DATE (YY/MM/DD)	F0110	SHEET		
6 - 15	±0.1			DESIGNED		DATE (YY/MM/DD)	MODEL	1 OF 2
15 - 60	±0.15			CHECKED		DATE (YY/MM/DD)	F104OT-H-EL2	PART NO.
60 - 200	±0.2			APPROVED		DATE (YY/MM/DD)		
200 - ∞	±0.3			Dec 28, 2022				
 When you need your own displays.		Hong.						

NO.	COUNT	REVISIONS	DATE (YY/MM/DD)	APPROVED
△	x		' / /	
△	x		' / /	
.	x		' / /	

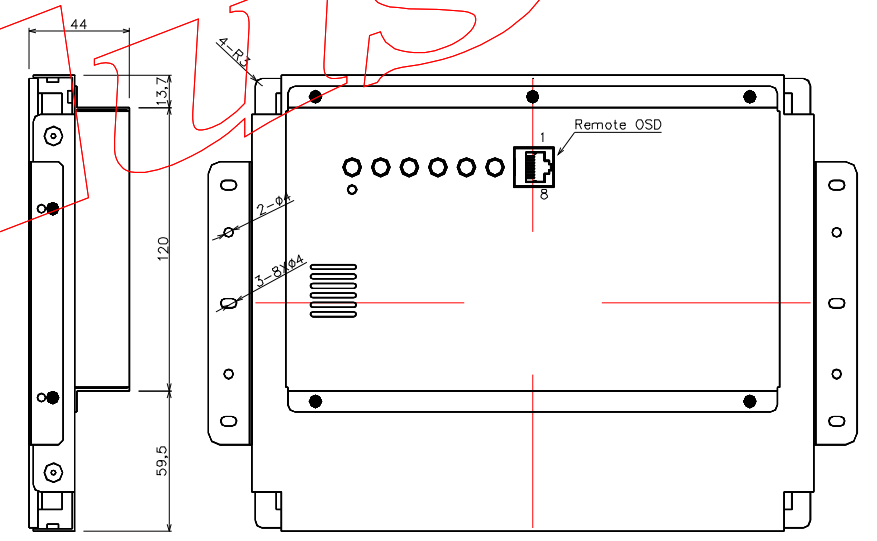
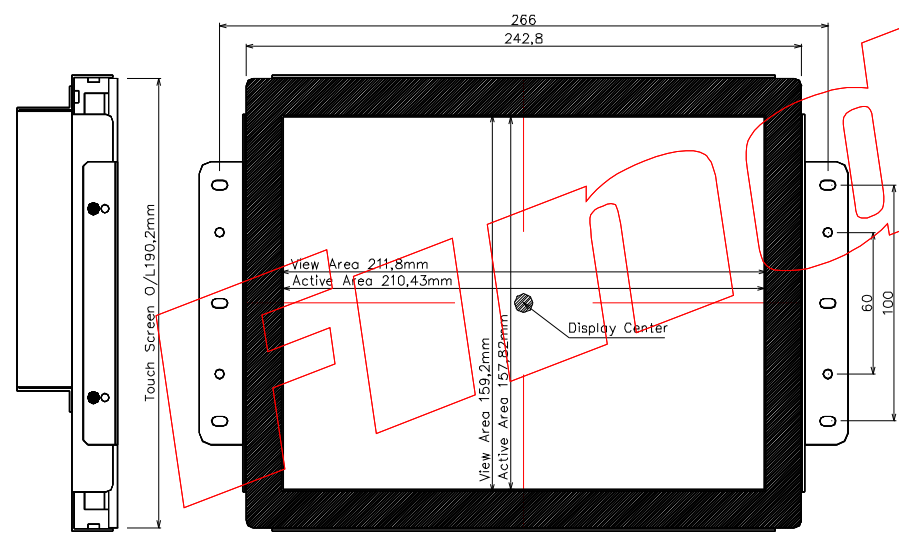
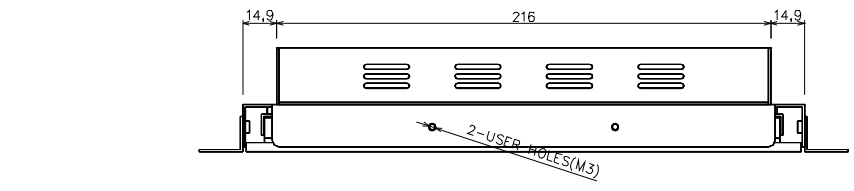
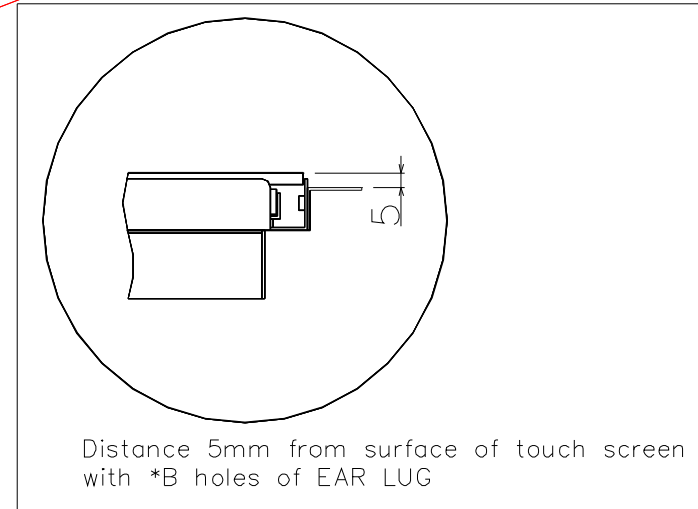
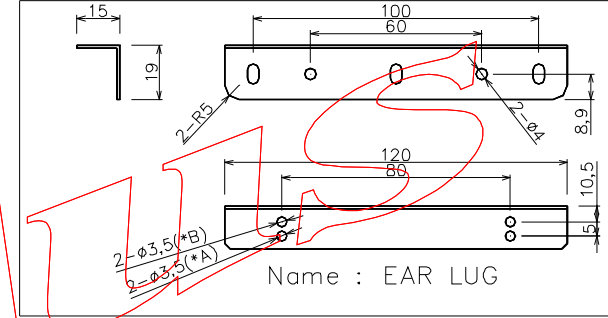
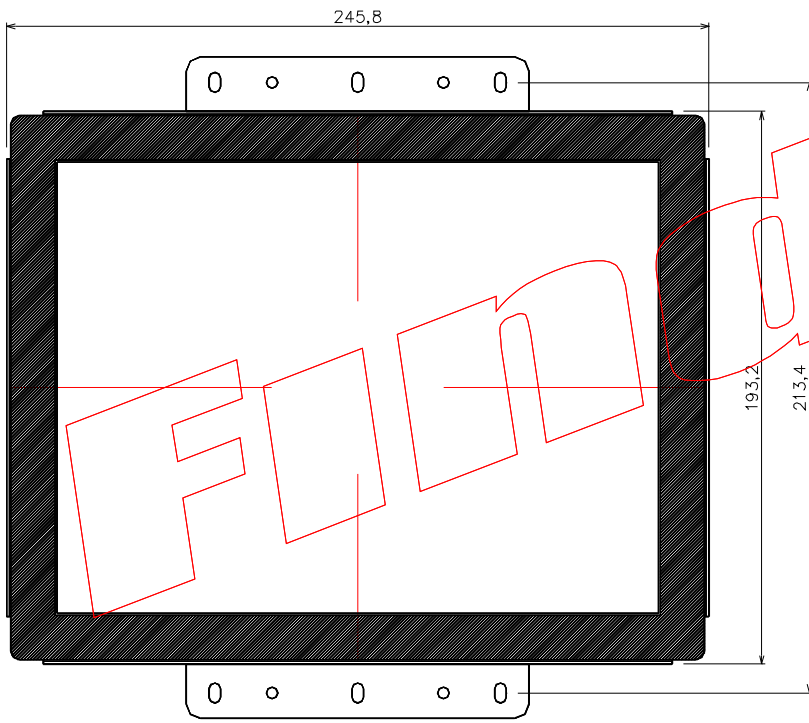

UNLESS OTHERWISE SPECIFIED DIMENSIONS ARE IN MILLIMETERS AND TOLERANCES ARE AS FOLLOWS:		SIZE	SCALE	QUANTITY	MATERIAL	REMARK
0 - 6	±0,02	 ANGULAR TOLERANCE: ±0,5°	DRAWN	DATE (YY/MM/DD)	F0110	SHEET 2 OF 2
6 - 15	±0,1			DESIGNED		
15 - 60	±0,15			CHECKED	DATE (YY/MM/DD)	F104OT-H-EL2
60 - 200	±0,2			APPROVED	DATE (YY/MM/DD)	1041F08L0
200 - ∞	±0,3			Dec 28, 2022	PART NO.	